

**SECURE TRAC CANTILEVER GATE - MONROE**  
**PLAN 1/8"=1'-0"**

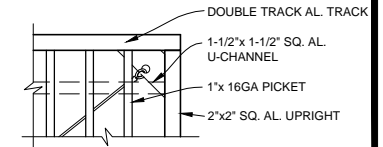

**RAIL**  
**DETAIL 1/2"=1'-0"**

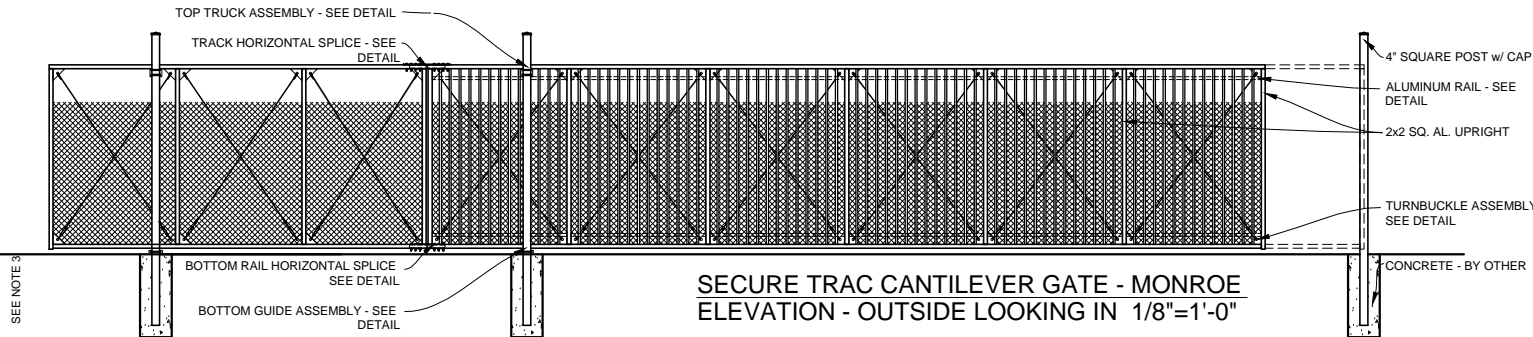

**SECURE TRAC CANTILEVER GATE - MONROE**  
**ELEVATION - OUTSIDE LOOKING IN 1/8"=1'-0"**

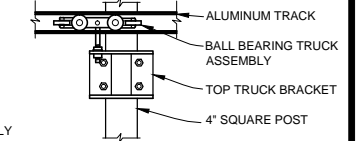

**TOP TRUCK ASSEMBLY**  
**DETAIL 1/2"=1'-0"**

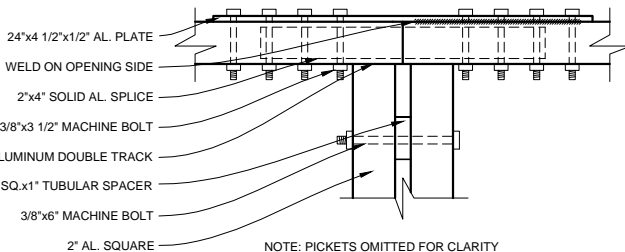

NOTE: PICKETS OMITTED FOR CLARITY  
**TRACK HORIZONTAL SPLICE**  
**DETAIL 1"=1'-0"**

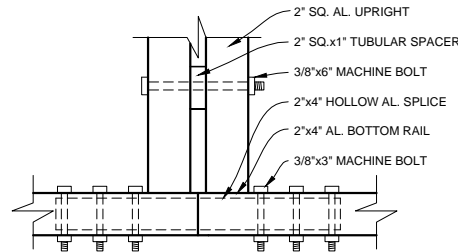

NOTE: PICKETS & FABRIC OMITTED FOR CLARITY  
**BOTTOM RAIL HORIZONTAL SPLICE**  
**DETAIL 1"=1'-0"**

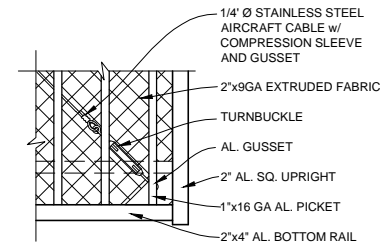

**TURNBUCKLE ASSEMBLY**  
**DETAIL 1/2"=1'-0"**

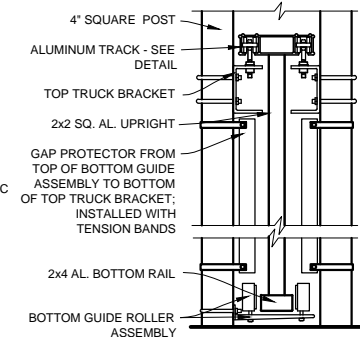

**BOTTOM GUIDE ASSEMBLY**  
**DETAIL 1/2"=1'-0"**

**NOTES:**

1. SPECIFICATIONS SHOWN CAN BE CHANGED BY THE MANUFACTURER ONLY.
2. ALL COMPONENTS OF THE GATE TO BE COATED BLACK. OTHER COLORS AVAILABLE.
3. VERIFY POST DEPTH AND FOOTING DIMENSIONS WITH LOCAL CODES AND SITE CONDITIONS.
4. CUSTOM DIMENSIONS ARE AVAILABLE UPON REQUEST.
5. OUTSIDE LOOKING IN, GATE LATCHES ON \_\_\_\_\_ (RIGHT AS SHOWN).
6. GATE OPENINGS OVER 40' WILL REQUIRE ADDITIONAL SUPPORT.
7. OPENINGS OVER 30' REQUIRE A FIELD SPLICE AND DOUBLE TRACK (AS SHOWN). GATE OPENINGS 30' OR LESS DO NOT REQUIRE A FIELD SPLICE AND ONLY REQUIRE A SINGLE ALUMINUM TRACK AND 2 SUPPORT POSTS.

OPENING INSIDE FACE OF POST TO INSIDE FACE OF POST	COUNTERBALANCE OUTSIDE FACE OF POST TO OUTSIDE FACE OF POST
10'-0"	6'-6"
11'-0" - 14'-0"	7'-6"
15'-0" - 22'-0"	10'-0"
23'-0" - 30'-0"	12'-0"
31'-0" - 40'-0"	16'-0"
41'-0" - 50'-0"	25'-0"

ADD 4" TO COUNTER BALANCE AND OPENING FOR OVERALL LENGTH OF GATE.



COPYRIGHT © MERCHANTS METALS  
 ALL RIGHTS RESERVED

**Merchants Metals**  
*the first name in fence solutions*

**SECURE TRAC CANTILEVER SLIDE GATE**  
**MONROE - 2 - 4 RAILS**

10' TO 50' WIDE OPENING x 6' TO 8' HIGH  
 (Nom.Dimension)

BY: J.R.

DATE: 20 SEPT 13

REV: D.D

DWG. NO.

SWP.MO.STC

SCALE:

AS NOTED