



## Commercial Grade Welded Ornamental Steel Fence

Designed with heavy-duty 14 gauge rails, 3/4" pickets and an architectural grade powder coat, V2 commercial fence provides the robust strength and long-lasting durability required for commercial installations.

V2 is manufactured using pre-galvanized 45,000 PSI steel which creates an added layer of protective coating. All panels are factory assembled to minimize installation time and ensure structural integrity, and pre-punched mounting holes offer simple and cost effective bracket installation.

Engineered with an internal patent pending pin-hinge system, V2 panels easily adjust to extreme changes in ground elevations and

can rack an impressive 30" per 8' section. This feature, along with the innovative rail design, provides the added benefit of no visible fasteners from either side of the fence and rails that are perfectly smooth, with no unsightly picket to rail connection points.

Once assembled, the galvanized steel fence components are coated with *FortressShield*, a premium coating process which includes a corrosion resistant E-Coat followed by an architectural grade powder top coat. This process produces long lasting, maintenance-free performance for years to come.



## V2 FEATURES

- 30" of Adjustability in an 8' Section
- Pre-Galvanized for Durability
- E-Coat and Architectural Grade Powder Top Coat
- Rigid Welded Steel Construction
- No Visible Fasteners
- Virtually Maintenance Free
- 20 Year Limited Warranty

### FortressShield Powder Coat Process

V2 pickets, posts and rails are produced with pre-galvanized 45,000 PSI steel and all components receive the *FortressShield* powder coat process.

Galvanized components are cleaned with a non-petroleum solvent, followed by the application of a sealing zinc phosphate coating. Immediately after sealing, components are coated with a corrosion resistant E-Coat, followed by an architectural grade powder top coat. This high-end *FortressShield* coating process ensures that each V2 system will provide years of worry free performance.

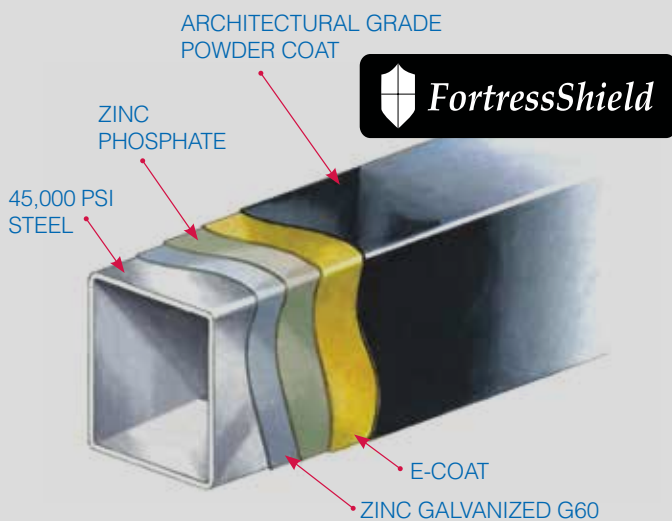

### V2 Adjustability

V2 is designed with an internal patent pending pin-hinge system which enables the panels to easily accommodate aggressive changes in ground elevations. With 30" of adjustability in each 8' section, V2 provides the perfect solution to changes in ground elevations and eliminates the need for costly and time-consuming stair stepping.

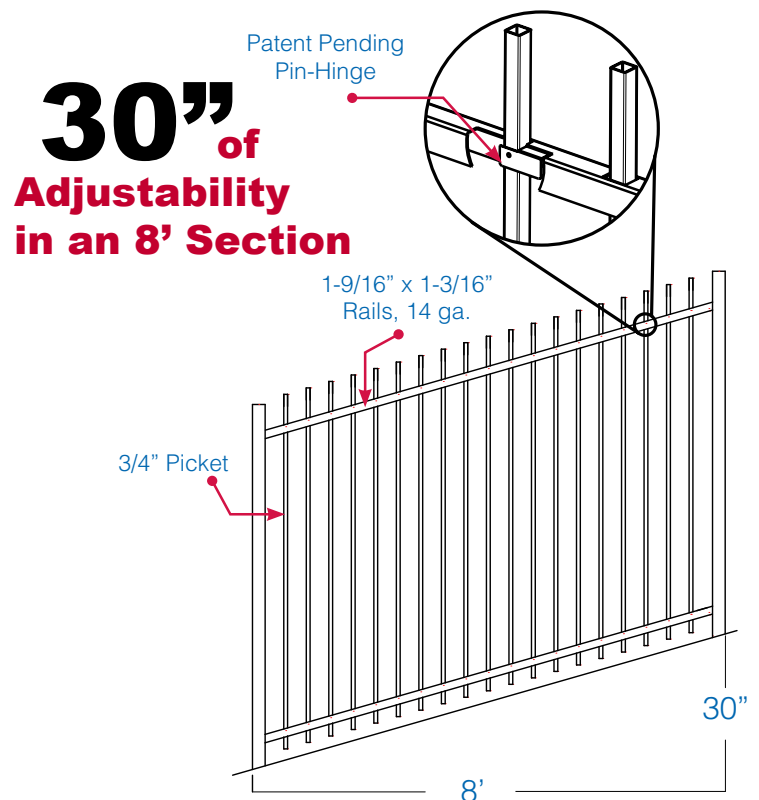



### FLAT TOP

A clean design with no pickets above the top rail.

Available in 2 or 3 rail styles.

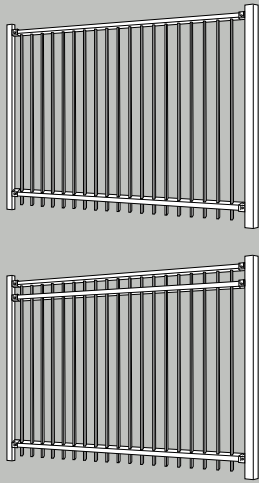

### PRESSED SPEAR

A secure and elegant design with pressed spear pickets.

Available in 2 or 3 rail styles.

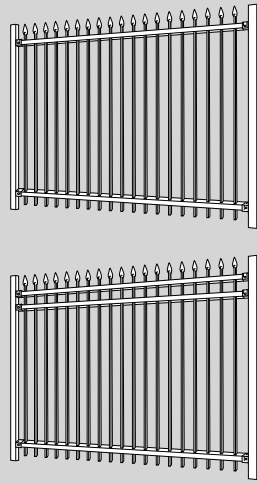

### EXTENDED PICKET

A traditional design with square top pickets.

Available in 2 or 3 rail styles.

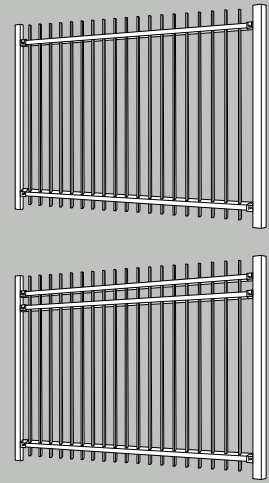

## Gates

A large selection of standard and custom gate sizes and styles are available to coordinate with your V2 fence system.

Walk Gate	Standard Opening - 4'
Drive Gate	Standard Opening - 8' Single Leaf
Cantilever Gate	Standard Opening Up To 40' x 10' Height
V-Track Roll Gate	Standard Opening Up To 40' x 10' Height
Swing Gate	Standard Single Swing Opening Up To 18' x 10' Height

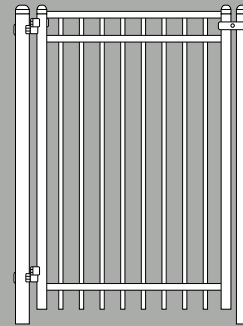

Flat Top Walk Gate

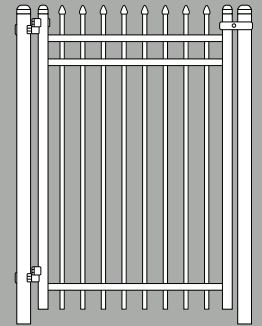

Pressed Spear Walk Gate

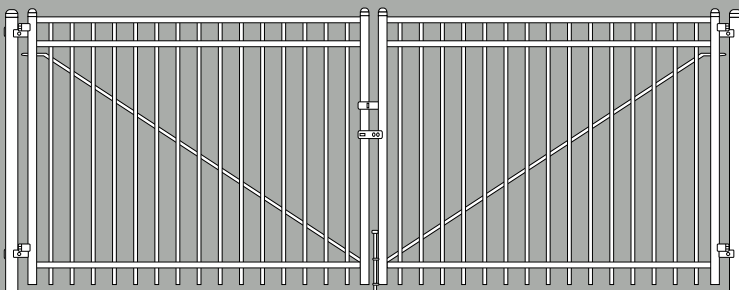

Drive Gate / Swing Gate

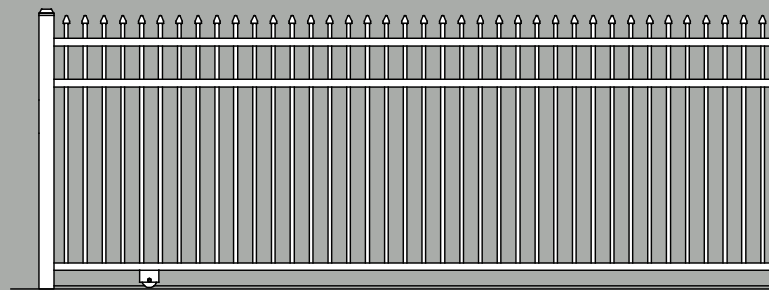

V-Track Roll Gate



**CURVED TOP**

A high security design with curved press spear pickets.

Available in 2 or 3 rail styles.

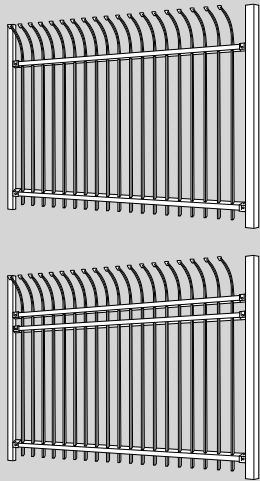

**FLAT TOP / FLAT BOTTOM**

A clean design with no pickets above the top or below the bottom rail.

Available in 2 or 3 rail styles.

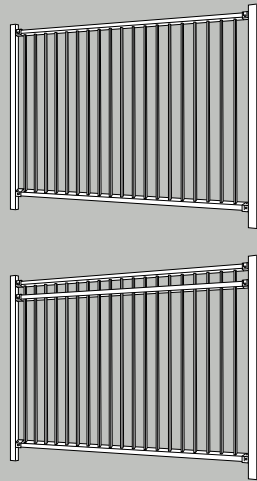

**BRACKETS**



Exterior One Direction (EX-106)



Exterior Two Direction (EXW-206)



Exterior Three Direction (EXW-306)



Exterior Swivel Bracket (EXS-106)

**POSTS**

POSTS	2.5", 3", 4", 6", 8"
HEIGHT	72", 84", 96", 108", 120", 132"
GAUGE	Various Gauge Sizes Available

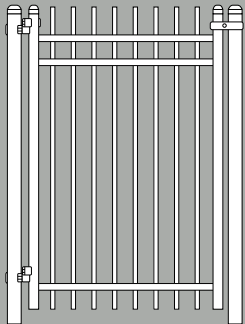

Extended Picket Walk Gate

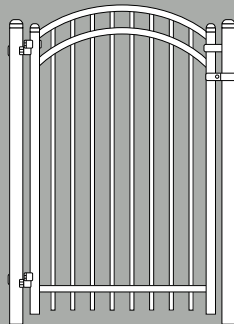

Flat Top Arched Walk Gate

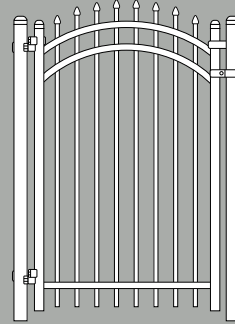

Pressed Spear Arched Walk Gate

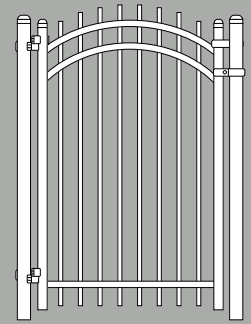

Extended Picket Arched Walk Gate

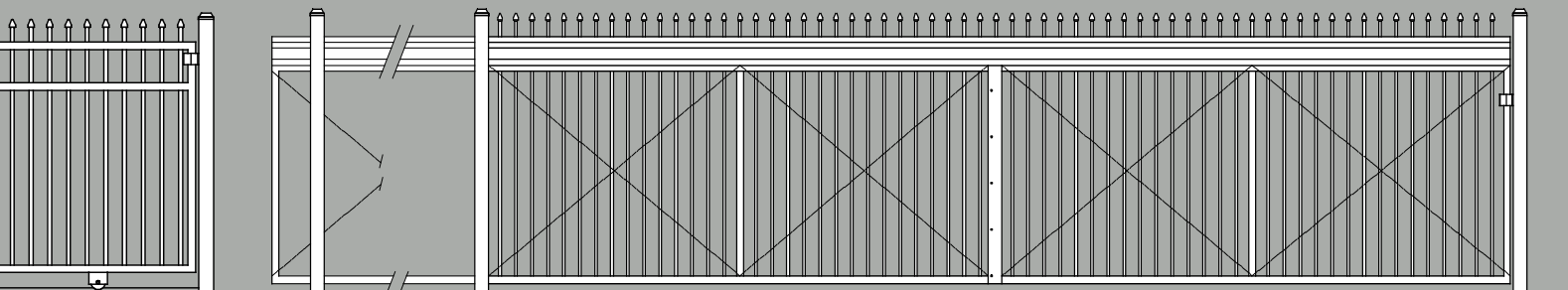

Cantilever Gate

# PRODUCT SPECIFICATIONS

Picket Size	3/4 inch square, 14 gauge or 16 gauge
Rail Size	1-9/16 inch x 1-3/16 inch, 14 gauge
Panel Length	90-1/2 inch
Panel Heights Available*	34", 46", 54"**, 58", 70", 82", 94"
Panel Styles Available	Flat Top, Pressed Spear, Extended Picket, Flat Top/Flat Bottom, Curved Top Available in 2 and 3 Rail***

\*Panel heights not available in all styles. 82" and 94" available in 14 ga. pickets only.

\*\* 54" panel only available with Flat Top / Flat Bottom style



## ACCESSORIES

Decorative Ring Inserts



Triad Spear



Quad Flair with Ball



Fleur de Lis



Curved Top Line Post Cap

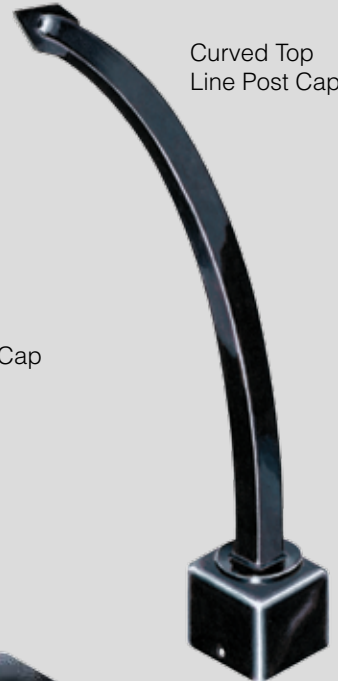

Curved Top Corner Post Cap



Ball Top Post Cap

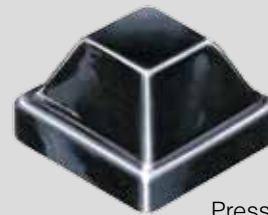

Pressed Dome Post Cap